

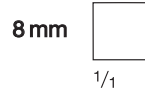

Spreizzange n. Inge
modifiziert n. Dahmen
Dahmen-Inge
Lamina Spreader

Gerade, Rastensperre, 280 mm
Straight, bar ratchet, 280 mm



75-2633/01

Max. Spreizweite 80 mm
Total opening 80 mm

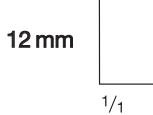

75-2633/02

Max. Spreizweite 80 mm
Total opening 80 mm



Spreizzange n. Inge
modifiziert n. Dahmen
Dahmen-Inge
Lamina Spreader

Gerade, Schraubenarretierung,
280 mm

*Straight, screw locking mechanism,
280 mm*

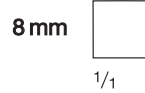

75-2633/11

Max. Spreizweite 35 mm
Total opening 35 mm

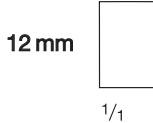

75-2633/12

Max. Spreizweite 35 mm
Total opening 35 mm



Spreizzange n. Inge
modifiziert n. Dahmen

**Dahmen-Inge
Lamina Spreader**

Gebogen, Rastensperre, 280 mm
Curved, bar ratchet, 280 mm

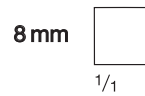

75-2634/01

Max. Spreizweite 65 mm
Total opening 65 mm

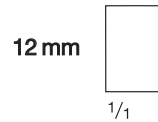
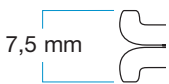

75-2634/02

Max. Spreizweite 65 mm
Total opening 65 mm

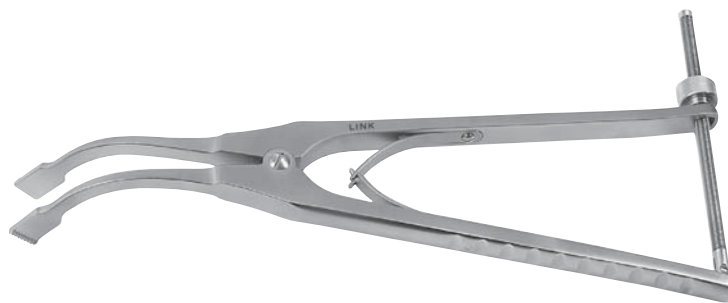

Spreizzange n. Inge
modifiziert n. Dahmen

**Dahmen-Inge
Lamina Spreader**

Gebogen, Schraubenarretierung,
280 mm
*Curved, screw locking mechanism,
280 mm*

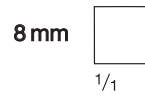

75-2634/11

Max. Spreizweite 65 mm
Total opening 65 mm

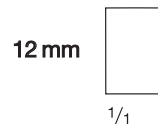

75-2634/12

Max. Spreizweite 65 mm
Total opening 65 mm



Spreizzange
modifiziert n. Scaglietti
Scaglietti Lamina Spreader

Gerade, 280 mm
Straight, 280 mm

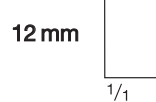
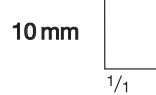
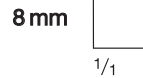

75-2634/03
Max. Spreizweite/Total opening
55 mm

75-2634/04
Max. Spreizweite/Total opening
55 mm

75-2634/06
Max. Spreizweite/Total opening
50 mm



Spreizzange
modifiziert n. Scaglietti
Scaglietti Lamina Spreader

Gebogen, 280 mm
Curved, 280 mm

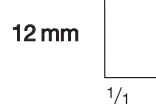
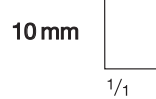
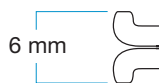
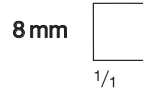

75-2634/13
Max. Spreizweite/Total opening
55 mm

75-2634/14
Max. Spreizweite/Total opening
55 mm

75-2634/16
Max. Spreizweite/Total opening
55 mm



Spreizzange
modifiziert n. Scaglietti
Scaglietti Lamina Spreader

Stark gebogen, 280 mm
Strongly curved, 280 mm

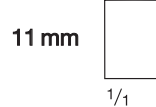

75-2634/05
Max. Spreizweite/Total opening
55 mm



Zwischenwirbelspreizer
Intervertebral Spreader

Maul gebogen, 280 mm
Jaws curved, 280 mm

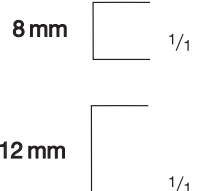
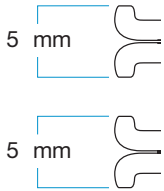

75-2639/08

Max. Spreizweite/Total opening
28 mm

75-2639/12

Max. Spreizweite/Total opening
28 mm



Spreizzange n. Inge,
kurzes Modell, stark gebogen
Inge Lamina Spreader
short Model, strong curved

170 mm
170 mm



75-2635

Max. Spreizweite/Total opening
35 mm



HWS-Wirbelkörperspreizer
Cervical Intervertebral Spreader

75-6690

Maulbreite 12 mm, max. Spreizweite
10 mm, Gesamtlänge 245 mm
Jaw width 12 mm, total opening 10 mm,
total length 245 mm



75-6691

Aufsatzinstrument mit Schlagplatte,
für 75-6690
Attachable Impact Bar, for 75-6690

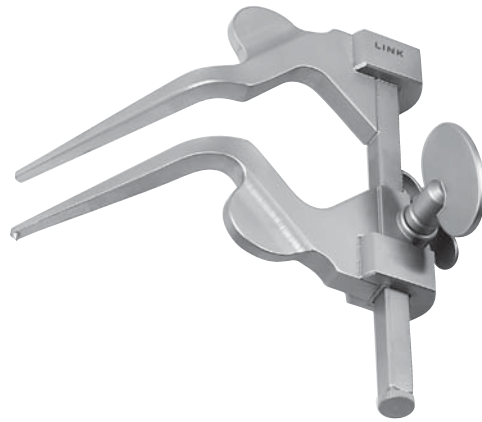

**Wirbelkörperspreizer
n. Cloward**
Cloward Lamina Spreader

Scharfe Dornen seitlich
Sharp teeth at shanks laterally

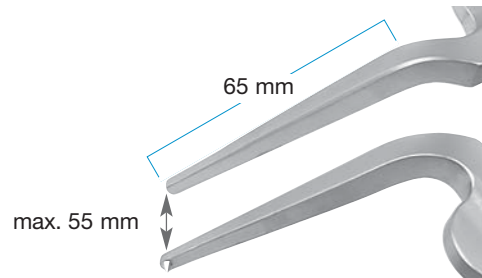

75-2636/01

2 x 1 Dorn
2 x 1 teeth

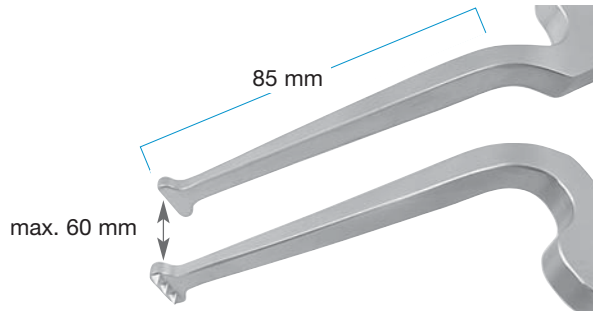

75-2636/02

2 x 3 Dornen
2 x 3 teeth

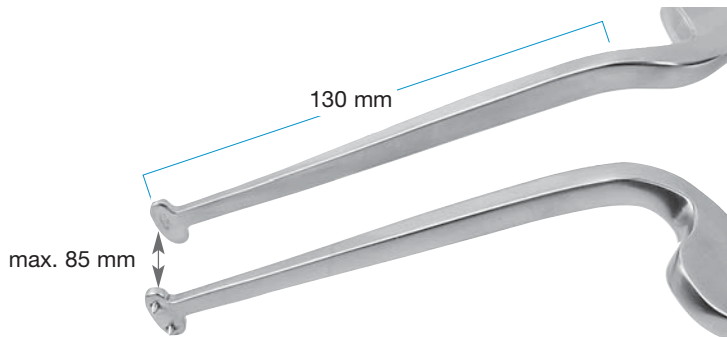

75-2636/03

2 x 2 Dornen
2 x 2 teeth

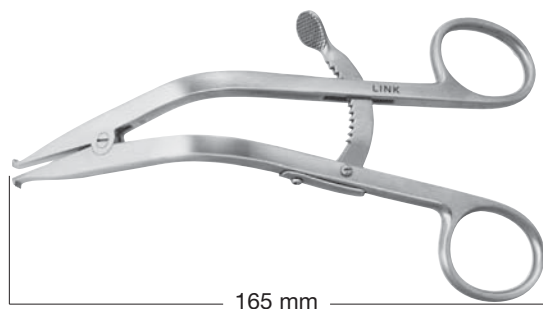

Spreizzange

Lamina Spreader

Ringgriffe, feines Modell,
165 mm

*Ring Handles, delicate model,
165 mm*



75-3400/35

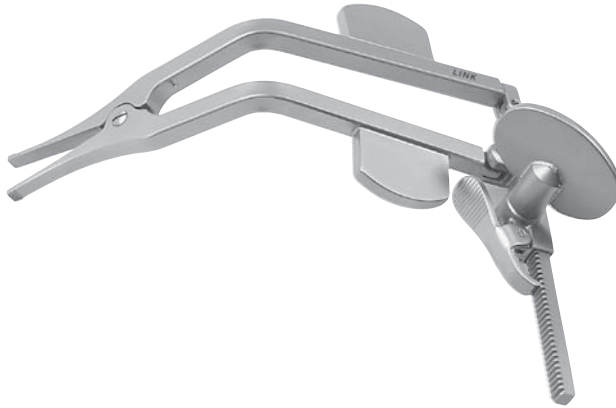

Wirbelkörperspreizer
Lamina Spreader

Maulbreite 4 mm, gewinkelt
4 mm wide jaws, curved

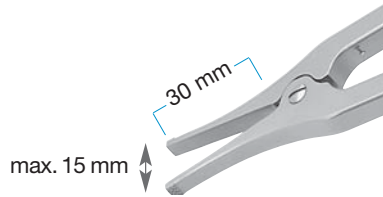

4 mm 
1/1

75-2636/05

130 mm Gesamtlänge
130 mm total length

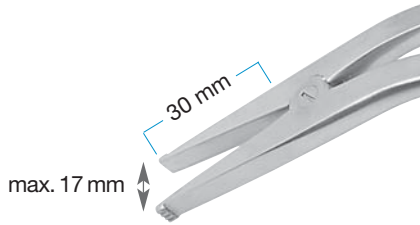

4 mm 
1/1

75-2636/07

150 mm Gesamtlänge
150 mm total length

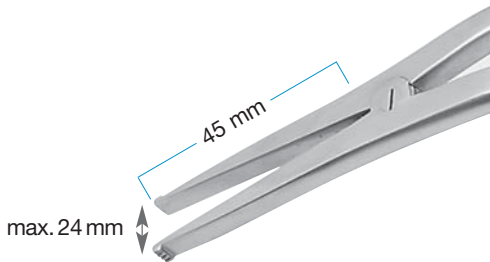

4 mm 
1/1

75-2636/08

170 mm Gesamtlänge
170 mm total length

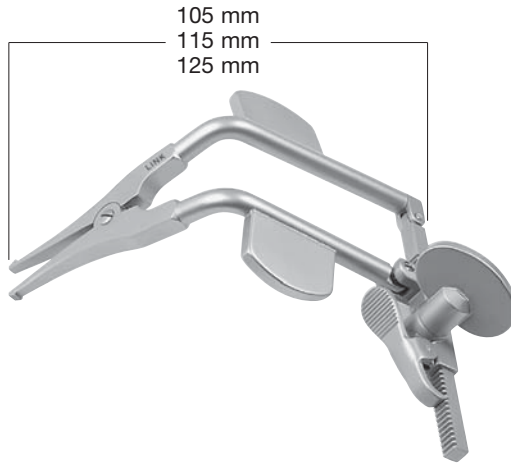

Wirbelkörperspreizer
feines Modell

Lamina Spreader
delicate model

Maulbreite 3 mm
Jaw width 3 mm

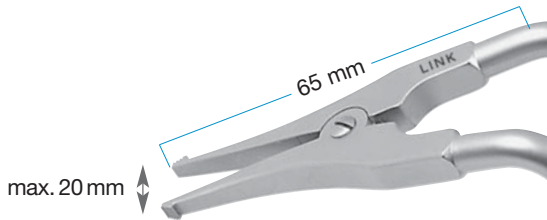

3 mm 
1/1

75-2636/10

105 mm Gesamtlänge
105 mm total length

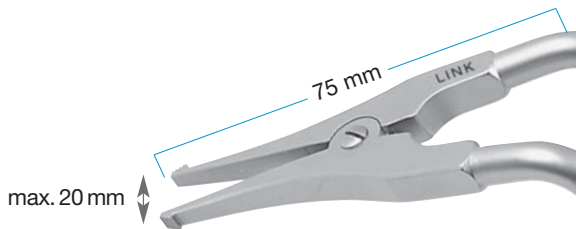

3 mm 
1/1

75-2636/12

115 mm Gesamtlänge
115 mm total length

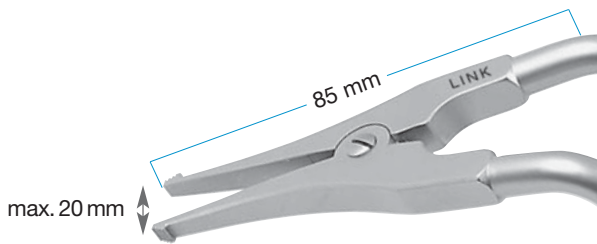

3 mm 
1/1

75-2636/14

125 mm Gesamtlänge
125 mm total length



Vertebralspreizer
extra kräftiges Modell

Vertebral Spreader
extra strong model

Griff leicht gewinkelt, doppelt übersetzt,
Schraubenarretierung, 430 mm

*Handle slightly curved, double action,
screw locking mechanism, 430 mm*

75-2638



10 mm

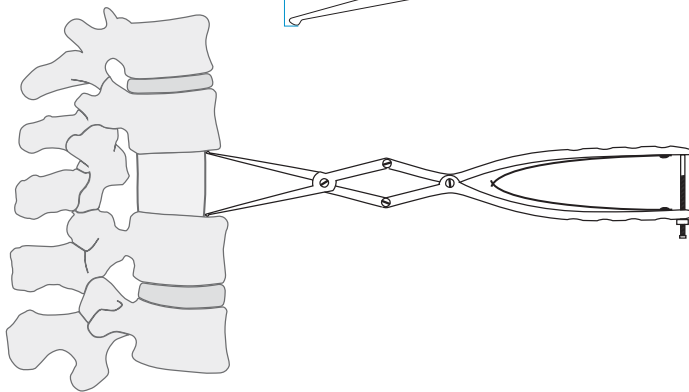
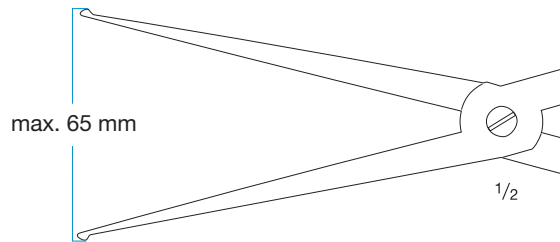

10 mm

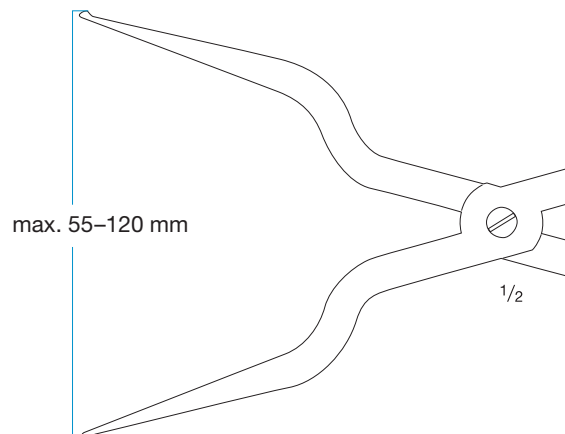

75-2638/02