

Wundspreizer n. Weitlaner
Weitlaner Retractor

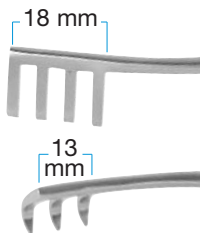

75-2546

Scharfe Zähne, 160 mm
Sharp prongs, 160 mm

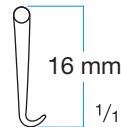

75-2548

Stumpfe Zähne, 160 mm
Blunt prongs, 160 mm

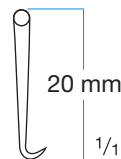
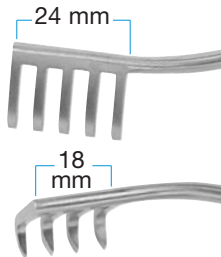

75-2550

Scharfe Zähne, 170 mm
Sharp prongs, 170 mm

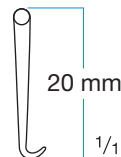

75-2552

Stumpfe Zähne, 170 mm
Blunt prongs, 170 mm

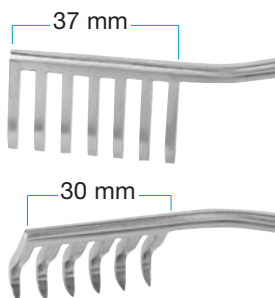

75-2554

Scharfe Zähne, 210 mm
Sharp prongs, 210 mm



75-2555

Stumpfe Zähne, 210 mm
Blunt prongs, 210 mm



**Wundspreizer n. Weitlaner
modifiziert n. Dahmen**
Dahmen Weitlaner Retractor

Abgewinkelt, 180 mm
Angled, 180 mm

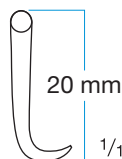
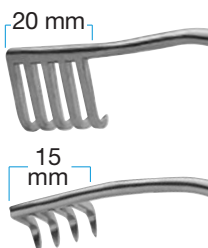

75-2556
Halbscharfe Zähne
Semi-sharp prongs





Wundspreizer n. Adson
Adson Retractor

265 mm

265 mm

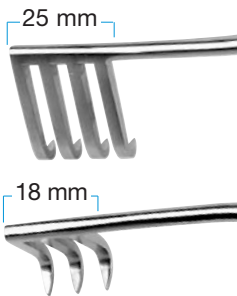

75-2612

Gebogen, scharfe Zähne

Curved, sharp prongs



Wundspreizer n. Adson, modifiziert
Adson Retractor, modified

200 mm

200 mm

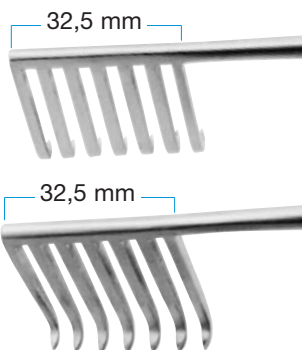

75-2613

Gewinkelt, scharfe Zähne

Angled, sharp prongs



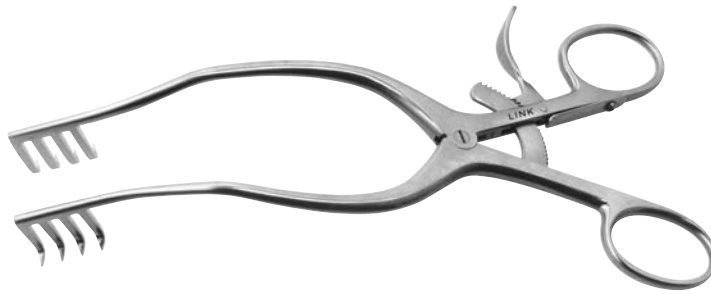

Wundspreizer n. Anderson-Adson
Anderson-Adson Retractor

Gebogen, 190 mm
Curved, 190 mm

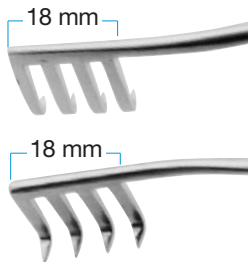

75-2614
Scharfe Zähne
Sharp prongs



75-2615
Stumpfe Zähne
Blunt prongs



Wundspreizer n. Cloward
Cloward Retractor

Gebogen, 140 mm
Curved, 140 mm

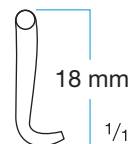
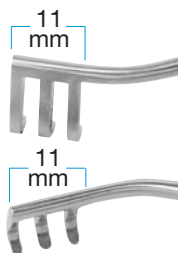

75-2602
Stumpfe Zähne
Blunt prongs





**Wundspreizer
Retractor**

Rechts und links unterschiedliche
Zahnlängen, scharfe Zähne, 280 mm
*Right and left divergent prong depth,
sharp prongs, 280 mm*

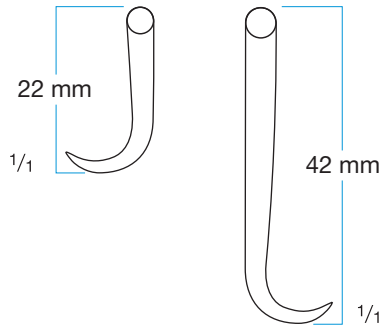
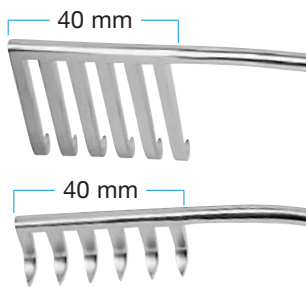

75-2616

Lange Zahnreihe rechts,
kurze Zahnreihe links

*Long prongs right,
short prongs left*

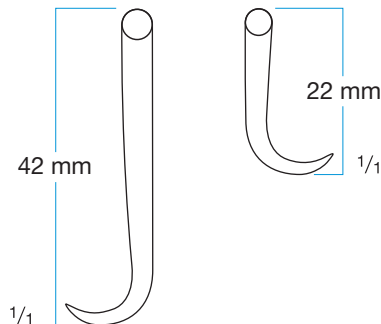
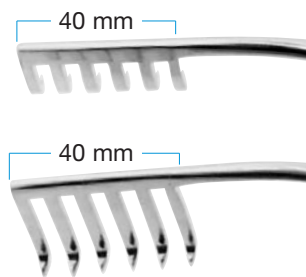

75-2618

Lange Zahnreihe links,
kurze Zahnreihe rechts

*Long prongs left,
short prongs right*

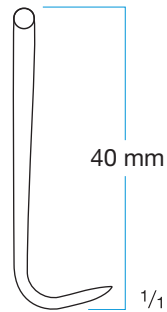
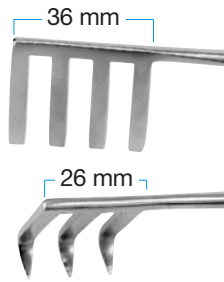

Wundspreizer Modell LINK
LINK self-retaining Retractor

S-förmig, scharfe Zähne,
Gesamtlänge 275 mm

*S-shaped, sharp prongs,
total length 275 mm*

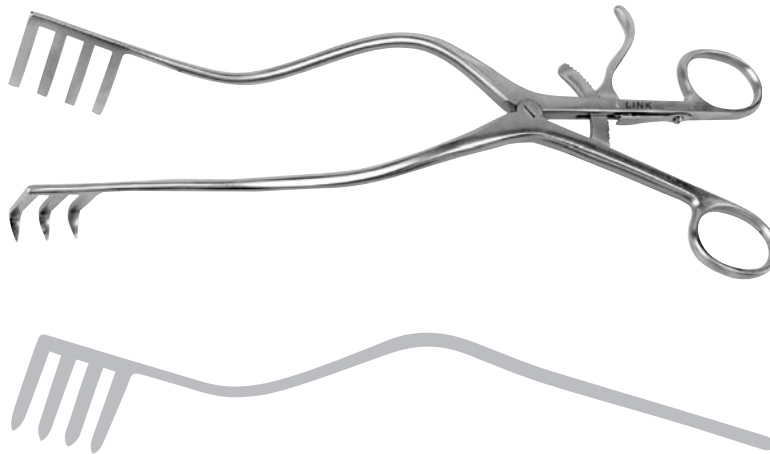

75-2619/01

Proximal konvex,
distal konkav

*Convex proximally,
concave distally*

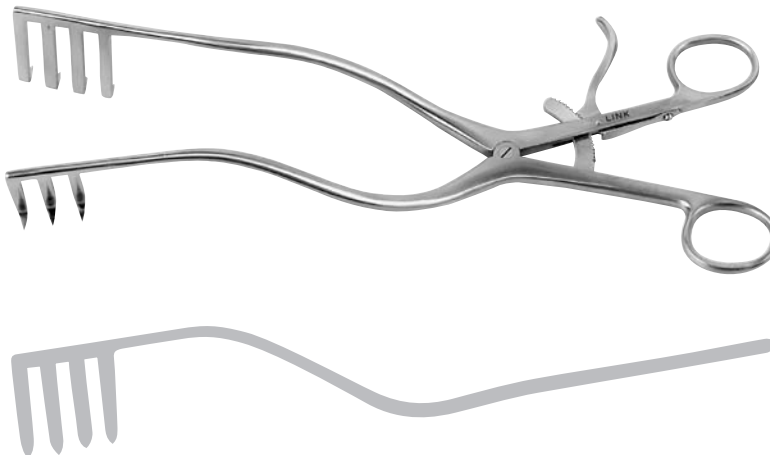

75-2619/02

Proximal konkav,
distal konvex

*Concave proximally,
convex distally*



Wundspreizer Baby-Adson
Baby-Adson Retractor

Stufenweise abwinkelbar,
165 mm

Gradually adjustable hinged arms,
165 mm

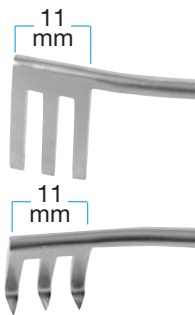

75-2598/01

Scharfe Zähne
Sharp prongs



75-2598/02

Stumpfe Zähne
Blunt prongs



Wundspreizer Baby-Adson
Baby-Adson Retractor

Abwinkelbar, 165 mm
Hinged arms, 165 mm

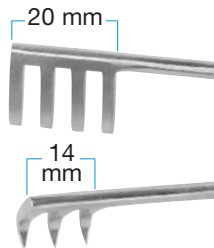

75-2600

Scharfe Zähne
Sharp prongs



75-2601

Stumpfe Zähne
Blunt prongs



Wundspreizer n. Dahmen
Dahmen Retractor

Abwinkelbar, scharfe Zähne,
ein Schenkel gerade,
ein Schenkel 20 mm versetzt,
210 mm

*Hinged arms, sharp prongs,
one arm straight and one arm
20 mm offset, 210 mm*

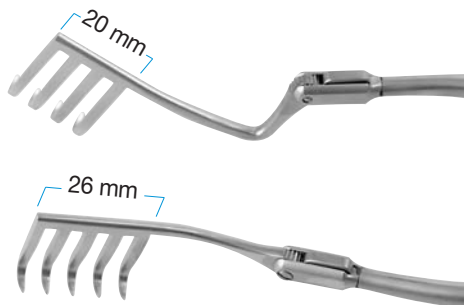

75-2609/01

Linker Schenkel gerade,
rechter Schenkel versetzt

*Left arm straight,
right arm offset*

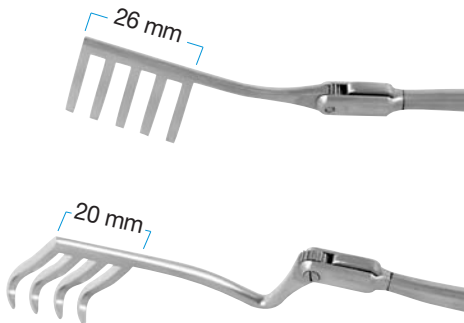

75-2609/02

Rechter Schenkel gerade,
linker Schenkel versetzt

*Right arm straight,
left arm offset*

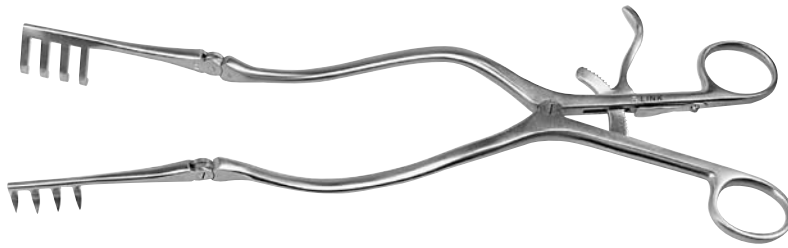

Wundspreizer Modell LINK
LINK Retractor

S-förmig und abwinkelbar, proximal konvex und distal konkav, 315 mm
S-shaped, hinged arms, proximally convex and distally concave, 315 mm

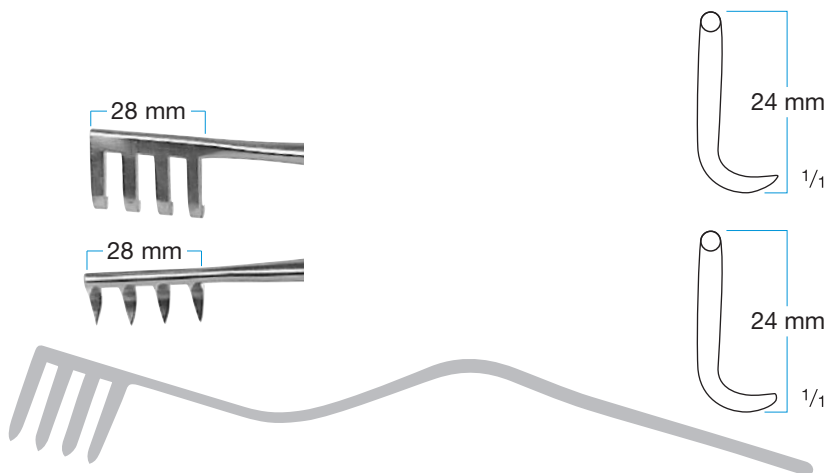

75-2619/03

Scharfe Zähne
Sharp prongs

75-2619/04

Stumpfe Zähne
Blunt prongs



Wundspreizer Modell LINK
LINK Retractor

S-förmig und abwinkelbar, proximal konkav und distal konvex, 315 mm
S-shaped, hinged arms, proximally concave and distally convex, 315 mm

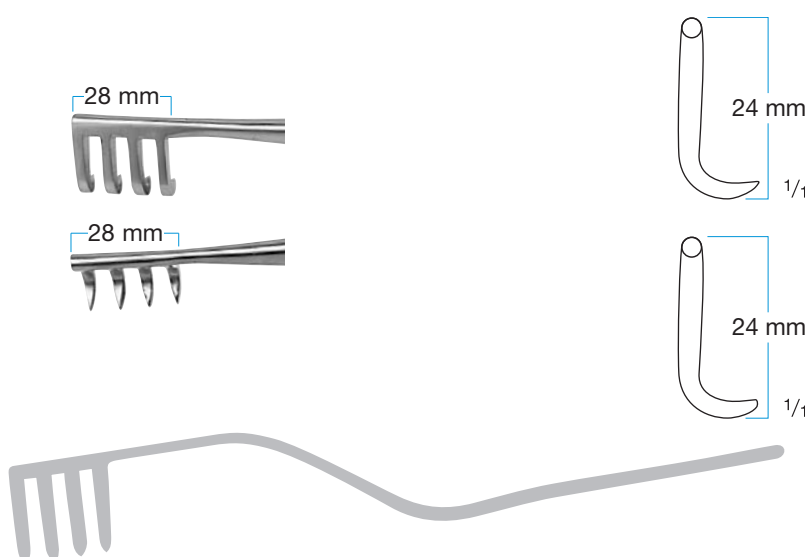

75-2619/05

Scharfe Zähne
Sharp prongs

75-2619/06

Stumpfe Zähne
Blunt prongs

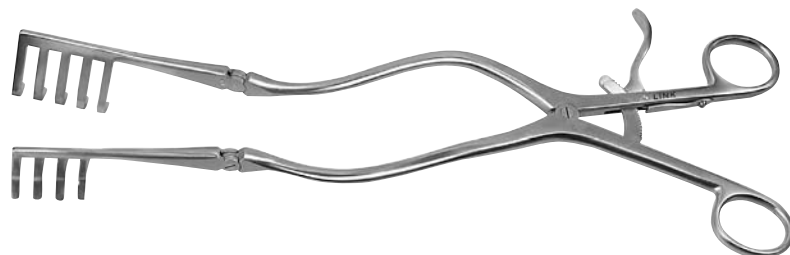

Wundspreizer Modell LINK
LINK Retractor

S-förmig, abwinkelbar,
stumpfe Zähne, 330 mm

*S-shaped, hinged arms,
blunt prongs, 330 mm*

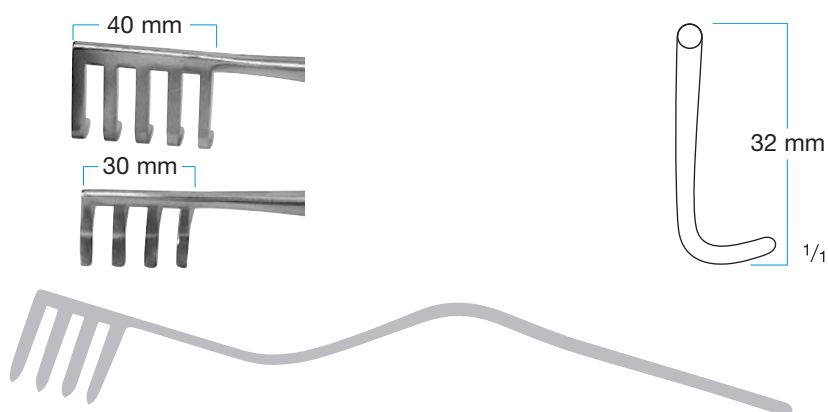

75-2619/07

Proximal konvex
distal konkav

*Convex proximally
concave distally*

75-2619/08

Proximal konkav
distal konvex
(o. Abb.)

*Concave proximally
convex distally
(not ill.)*



**Wundspreizer
n. Beckmann-Adson**
*Beckmann-Adson
Retractor*

Abwinkelbar, 310 mm
Hinged arms, 310 mm

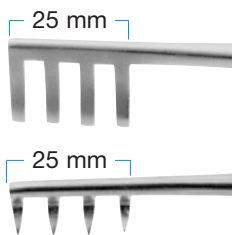

75-2620

Scharfe Zähne
Sharp prongs

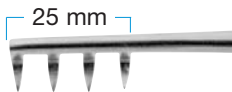

75-2621

Stumpfe Zähne
Blunt prongs



Wundspreizer n. Adson
Adson Retractor

Abwinkelbar, 330 mm
Hinged arms, 330 mm

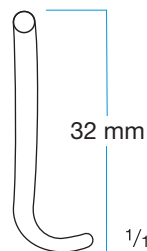
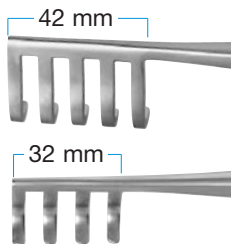

75-2622

Stumpfe Zähne
Blunt prongs



**Wundspreizer
n. Beckmann-Eaton**
Beckmann-Eaton Retractor

Abwinkelbar, 320 mm
Hinged arms, 320 mm

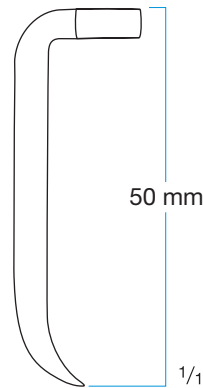
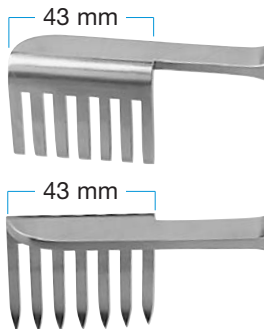

75-2624
Scharfe Zähne
Sharp prongs



Wundspreizer mit Inge-Griff
Retractor with Inge Handle

Abwinkelbar, 350 mm
Hinged arms, 350 mm

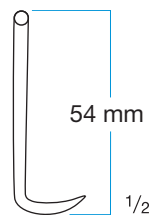
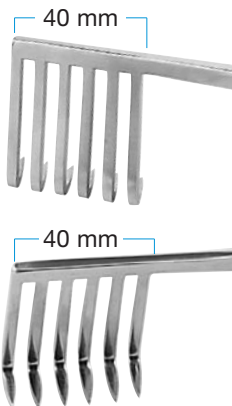

75-2625/01
Scharfe Zähne
Sharp prongs

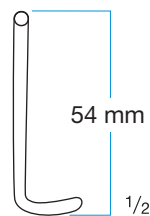

75-2625/02
Stumpfe Zähne
Blunt prongs



**Hemilaminektomiespreizer
n. Walton**

**Walton Hemilaminectomy
Retractor**

Rastensperre, 7 scharfe Zähne
(rechts oder links), Einzinkervalue mit
Kugel (rechts oder links), 210 mm

*Ratchet Lock, 7 sharp prongs (right
or left), single prong with ball point
(right or left), 210 mm*

75-2607/01

Zähne rechts,
Einzinkervalue links

*Prongs right,
single prong left*

75-2607/02

Zähne links,
Einzinkervalue rechts

*Prongs left,
single prong right*

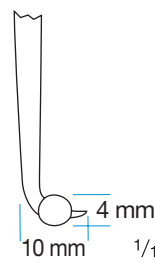
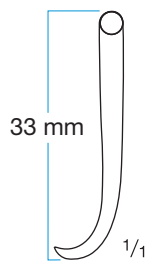
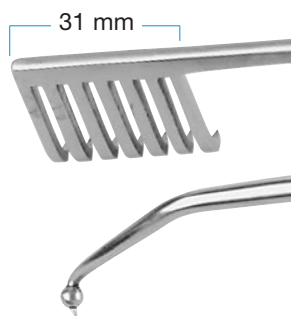

**Hemilaminektomiespreizer
n. Walton**

**Walton Hemilaminectomy
Retractor**

Zahnstangentrieb,
7 scharfe Zähne,
Einzinkervalue mit Kugel, 170 mm

*Ratchet action,
7 sharp prongs,
single prong with ball point, 170 mm*

75-2607/11

Zähne rechts,
Einzinkervalue links

*Prongs right,
single prong left*

75-2607/12

Zähne links,
Einzinkervalue rechts

*Prongs left,
single prong right*

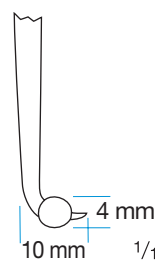
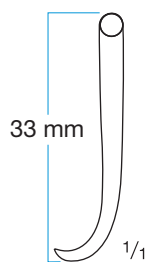
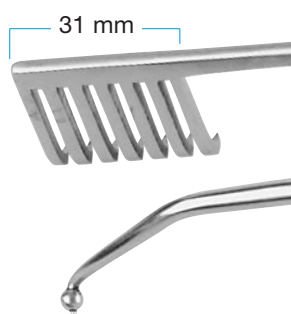



**Wundspreizer
n. Markham-Meyerding
Markham-Meyerding
Retractor**

Gezahntes massives Blatt
(rechts oder links),
scharfe Einzinkervalue
(rechts oder links), 165 mm

*Solid blade (right or left), and sharp
single prong (right or left), 165 mm*

Sonderbreiten auf Anfrage

**Special blade widths available
on request**

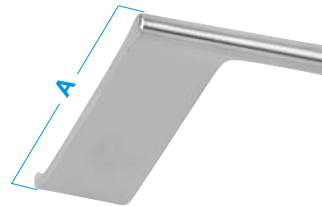
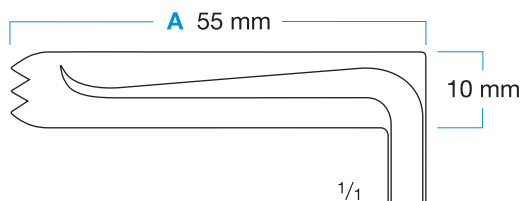

Massives Blatt rechts

Solid blade right

75-2603/03

55 mm x 10 mm

75-2603/05

65 mm x 10 mm

75-2603/07

55 mm x 20 mm

75-2603/09

65 mm x 20 mm

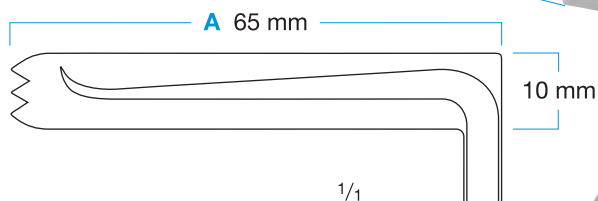

Massives Blatt links

Solid blade left

75-2603/04

55 mm x 10 mm

75-2603/06

65 mm x 10 mm

75-2603/08

55 mm x 20 mm

75-2603/10

65 mm x 20 mm

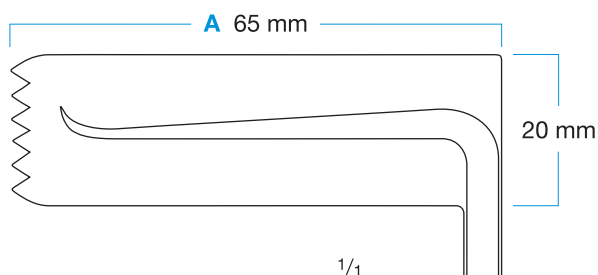
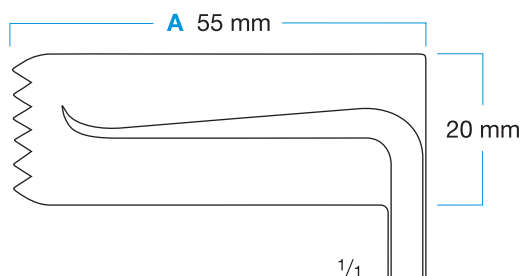



Wundspreizer n. Meyerding
Meyerding Retractor

Gezahnte massive Blätter
Solid serrated blades

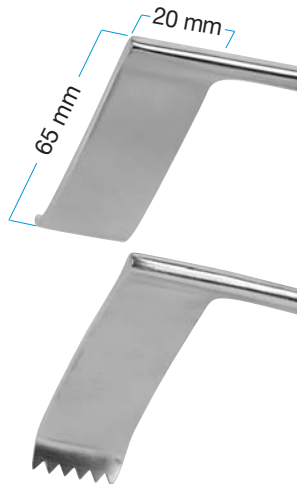
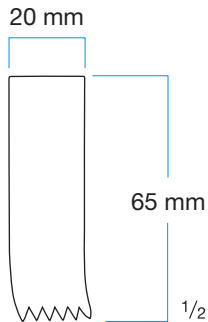

75-2603/22

Gesamtlänge 165 mm
Total length 165 mm

75-2603/23

Gesamtlänge 200 mm
Total length 200 mm

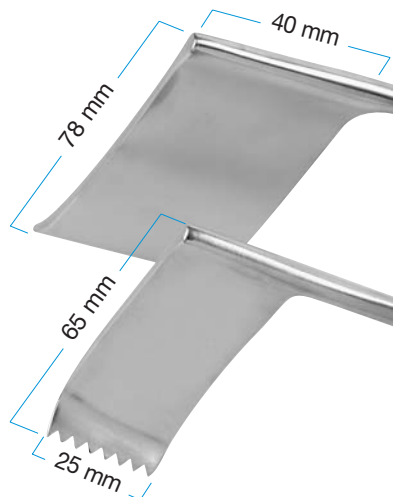
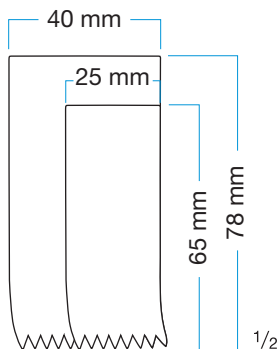

75-2603/25

Gesamtlänge 175 mm
Total length 175 mm

Rechtes Blatt 40 x 78 mm,
Linkes Blatt 25 x 65 mm

*Right blade 40 x 78 mm,
Left blade 25 x 65 mm*

75-2603/26

Gesamtlänge 175 mm
Total length 175 mm

Rechtes Blatt 25 x 65 mm,
Linkes Blatt 40 x 78 mm

*Right blade 25 x 65 mm,
Left blade 40 x 78 mm*

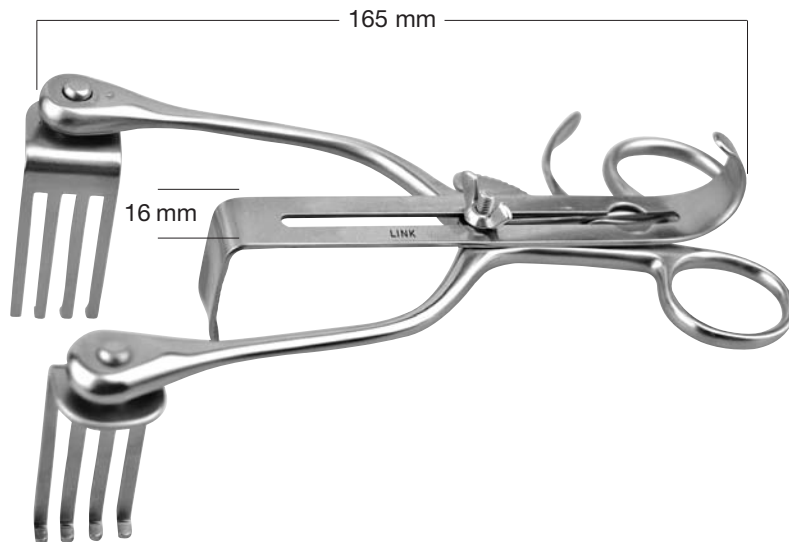

**Wundspreizer
Retractor**

75-2611/01

Wundspreizer mit einstellbaren Mittelvalven, komplett, inkl. je 1 Paar stumpfer 4-Zinkervalen, Valventiefe 28, 59 und 79 mm, Valvenbreite 22 mm, 3 einstellbare gezahnte Mittelvalven, Valventiefe 22, 28 und 32 mm, Valvenlänge 115, 115, 120 mm, Valvenbreite 16 mm, Spreizweite 75 mm, Gesamtlänge 165 mm

Retractor with adjustable center blades, complete, incl. 1 pair ea. blunt 4-prong blades, blade depth 28, 59 and 79 mm, blade width 22 mm, 3 adjustable toothed center blades, blade depth 22, 28 and 32 mm, blade length 115, 115, 120 mm, blade width 16 mm, total opening 75 mm, total length 165 mm

75-2611/02

Wundspreizer, ohne Valven

Retractor without blades

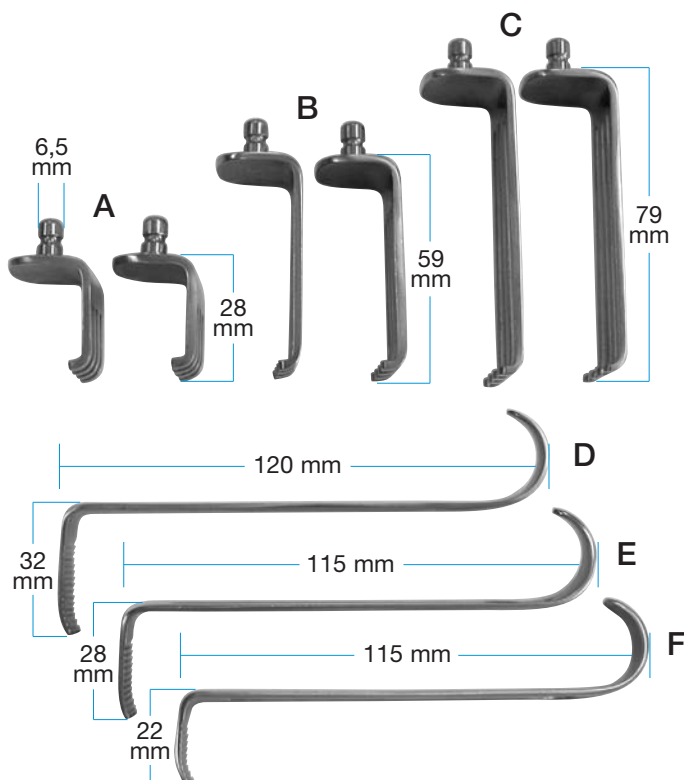

Seitenvalven / Lateral Blades

75-2611/03 (A)

22 x 28 mm

75-2611/04 (B)

22 x 59 mm

75-2611/05 (C)

22 x 79 mm

Mittelvalven / Center Blades

75-2611/06 (D)

120 x 16 x 32 mm

75-2611/07 (E)

115 x 16 x 28 mm

75-2611/08 (F)

115 x 16 x 22 mm

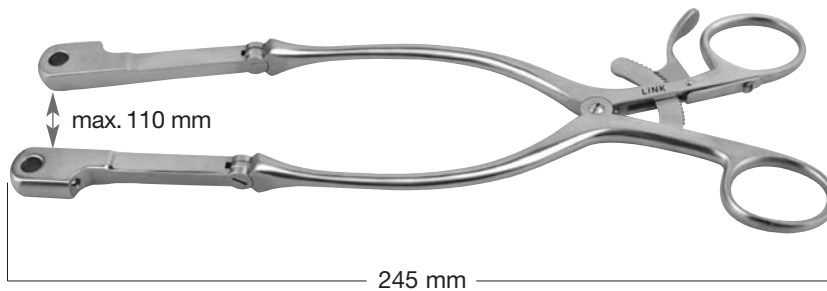

Wundspreizer n. Cloward
Cloward-type Retractor

Abwinkelbar, 245 mm
Hinged arms, 245 mm

75-2626/01

Wundspreizer, komplett,
mit 5 gezahnten Valven: 40, 45, 50,
55, 60 mm (75-2626/03 bis /07)

Spreader, complete,
with 5 toothed blades: 40, 45, 50,
55, 60 mm (75-2626/03 to /07)

75-2626/02

Wundspreizer ohne Valven
Retractor without blades

Zugehörige Valven siehe Seite A18
For blades see page A18



Wundspreizer n. Cloward
Cloward-type Retractor

abwinkelbar, Zahnstangentrieb,
220 mm
hinged arms, ratchet action,
220 mm

75-2627/01

Wundspreizer, komplett,
mit 5 gezahnten Valven: 40, 45, 50,
55, 60 mm (75-2626/03 bis /07)

Retractor, complete,
with 5 toothed blades: 40, 45, 50,
55, 60 mm (75-2626/03 to /07)

75-2627/02

Wundspreizer ohne Valven
Retractor without blades

Zugehörige Valven siehe Seite A18
For blades see page A18

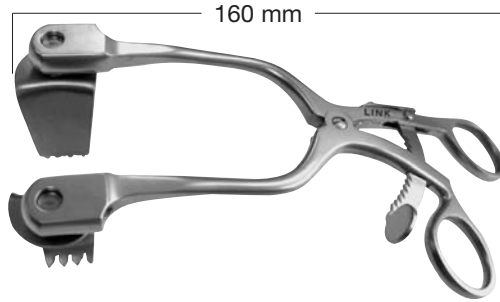

Wundspreizer n. Cloward
Cloward-type Retractor

Gebogen, 160 mm

Curved, 160 mm

75-2628/01

Wundspreizer, komplett, mit 5 gezahnten Valven: 40, 45, 50, 55, 60 mm (75-2626/03 bis /07)

Retractor, complete, with 5 toothed blades: 40, 45, 50, 55, 60 mm (75-2626/03 bis /07)

75-2628/02

Wundspreizer, ohne Valven

Retractor, without blades

Valven,
zu den Wundspreizern n.Cloward

*Blades,
for Cloward-type Retractors*

75-2626/01, 75-2627/01, 75-2628/01

Gezahnt
Toothed



A

40 mm
45 mm
50 mm
55 mm
60 mm

Aluminium
Aluminum

75-2626/03 **75-2626/13**
75-2626/04 **75-2626/14**
75-2626/05 **75-2626/15**
75-2626/06 **75-2626/16**
75-2626/07 **75-2626/17**

Ohne Zähne
Without teeth



A

40 mm
45 mm
50 mm
55 mm
60 mm

Aluminium
Aluminum

75-2628/03 **75-2628/13**
75-2628/04 **75-2628/14**
75-2628/05 **75-2628/15**
75-2628/06 **75-2628/16**
75-2628/07 **75-2628/17**